

WE'RE THINKING OF YOU

Thank you for purchasing an Electrolux appliance. You've chosen a product that brings with it decades of professional experience and innovation. Ingenious and stylish, it has been designed with you in mind. So, whenever you use it, you can be safe in the knowledge that you'll get great results every time. Welcome to Electrolux.

BEFORE USING YOUR APPLIANCE

Check for any damage or marks. If you find the appliance damaged or marked, you must report it within 7 days to claim for damages under the manufacturer's warranty. This does not affect your statutory rights.

Before you use the appliance, we recommend that you read through the whole user manual which provides the description of the product and its functions. It is important that the product is installed correctly and that you read the safety instructions carefully to avoid misuse and hazards.

For future reference, please store this booklet in a safe place.

CONDITIONS OF USE

This appliance is intended to be used in household and similar applications such as:

- Staff kitchen areas in shops, offices, and other working environments.
- Farmhouses.
- By clients in hotels, motels, and other residential type environments.
- Bed and breakfast type environments.

BEFORE YOU CALL

Please ensure you read the instruction manual fully before you call for service, or a full service fee could be applicable.

RECORD MODEL AND SERIAL NUMBER HERE:

Model: _____

Serial No: _____

CONTENTS

1. General warnings	3
2. Safety instructions	4
3. Product description	6
4. Accessories	6
5. How to use	7
6. Using the accessories	10
7. Cooking guides	11
8. Cleaning and maintenance	12
9. Specification	14
10. Customer care center	15

SYMBOLS



WARNING!

This symbol indicates information concerning your personal safety.



CAUTION!

This symbol indicates information on how to avoid damaging the appliance.



IMPORTANT!

This symbol indicates tips and information about use of the appliance.

IMPORTANT INFORMATION THAT MAY IMPACT YOUR MANUFACTURER'S WARRANTY

Adherence to the directions for use in this manual is extremely important for health and safety. Failure to strictly adhere to the requirements in this manual may result in personal injury, property damage and affect your ability to make a claim under the Electrolux manufacturer's warranty provided with your product. Products must be used, installed and operated in accordance with this manual. You may not be able to claim on the Electrolux manufacturer's warranty in the event that your product fault is due to failure to adhere this manual.

1. GENERAL WARNINGS

Important safety instructions, read carefully and keep for future reference. Pass the user manual on to possible new owners of the appliance.

NOTE! You must read these warnings carefully before installing or using the appliance. If you need assistance, contact your Customer Care Department. The manufacturer will not accept liability, should these instructions or any other safety instructions incorporated in this book be ignored.

Children and vulnerable people safety.

WARNING!

Risk of suffocation, injury or permanent disability.

- This appliance is not intended for use by persons (including children) with reduced physical, sensory, or mental capabilities, or lack of experience and knowledge, unless they have been given supervision or instruction concerning use of the appliance by a person responsible for their safety.
- Children should be supervised to ensure that they do not play with the appliance.
- Keep all packaging away from children.
- WARNING: Accessible parts may become hot during use. Young children should be kept away.

CAUTION!

Important safety instructions, read carefully and keep for future reference.

General safety

- Internally the appliance becomes hot when in operation. Do not touch the heating elements that are in the appliance.
- Always use oven gloves to remove or put in accessories or ovenware.
- Before maintenance isolate the power supply.
- If the door or door seals are damaged, the appliance must not be operated until it has been repaired by a competent person.
- The appliance is not intended to be operated by means of an external timer or separate remote-control system.
- Do not heat liquids and other foods in sealed containers of any material. They are liable to explode.
- Only use utensils and recommended accessories that are suitable to use in electric ovens.

- The use of accessories not recommended by the appliance manufacturer may cause hazard or injury.
- If smoke is emitted, switch off or unplug the appliance and keep the door closed to stifle any flames.
- The appliance should be cleaned regularly, and any food deposits removed.
- Failure to maintain the appliance in a clean condition could lead to deterioration of the surface that could adversely affect the life of the appliance and possibly result in a hazardous situation.
- The temperature of accessible surfaces may be high when the appliance is operating.
- Do not use harsh abrasive cleaners or sharp metal scrapers to clean the glass door since they can scratch the surface, which may result in shattering of the glass. Contact the Service Centre if require.
- If the supply cord is damaged, it must be replaced by the manufacturer or an authorized service agent or similarly qualified persons to avoid a hazard.

CAUTION!

In order to avoid a hazard due to inadvertent resetting of the thermal cut-out, this appliance must not be supplied through an external switching device, such as a timer, or connected to a circuit that is regularly switched on and off by the utility.

WARNING!

Ensure that the appliance is switch off before replacing the lamp to avoid the possibility of electric shock.

2. SAFETY INSTRUCTIONS

2.1 Installation

CAUTION!

- If the oven is positioned too close to the wall, the wall will be burned or stained. Be sure the curtain is not in contact with the oven body.
- Do not put anything between the bottom of the body and the counter surface on which it is set; such object could be burnt.
- When operating the oven, keep at least 10cm of space on all sides of the oven to allow adequate air circulation. It's recommended to have at least 30cm space between the top of oven and bottom of cabinet.

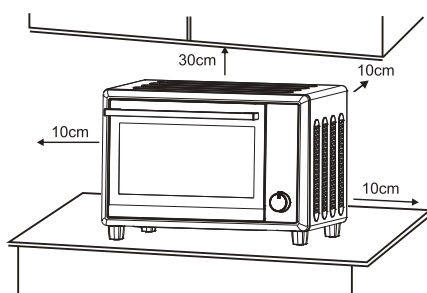

- The rear surface of appliances should be placed against the wall.
- Do not cover any parts of the oven with metal foil. This may cause overheating of the oven.
- Do not put anything on the oven while using it. The heat could cause deformation, crack, etc.
- Do not store any flammable material on the oven during operation, it can cause fire.
- Do not rest cooking utensils or baking dishes on the glass door, it could cause unit to fall.

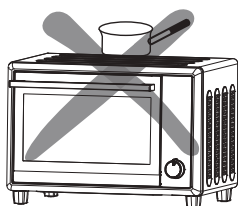

- The temperature of the door or the outer surface may be higher when the appliance is operating. Temperature of accessible surfaces may be high when the appliance is operating
- The metal parts and glass window of the door become extremely hot during use; be careful not to touch them when opening and closing the door.

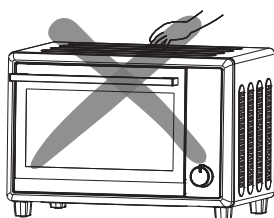

2.2 Electrical connection

CAUTION!

Risk of fire and electrical shock.

- AC power must be taken from a properly wired outlet. Insert the plug completely into the socket; if it is not: it will become abnormally hot.
- Do not use an electric light outlet. Never connect multiple plugs to the same outlet.
- When unplugging the cord, always take hold of the plug itself. Never pull on the cord; doing so could break the wires inside the cord.



- When using the oven, do not place the unit close to the gas burner or other source of high temperature or direct the electric fan at the oven as it could prevent the oven to get the correct temperature control.
- Do not the power cord nor handle the unit with wet hands. Always unplug the cord after use. Any malfunctioned unit with plug inserted into the outlet could cause fire hazard.



- When cooking oil-splashing dishes such as roast chicken, it is recommended to put 2 sheets of aluminum foils on a tray to diminish oil splashing.



2.3 Use

WARNING!

Risk of injury, burns or electric shock or explosion.

- Do not use outdoors.
- Do not use the appliance for other than intended use.
- Use this appliance in a household environment.
- Do not change the specification of this appliance.
- Make sure that the ventilation openings are not blocked.
- Do not leave the appliance unattended during operation.
- Do not apply pressure on the open door.
- Do not use the appliance as a work surface and do not use the cavity for storage purposes.
- Do not operate appliance without food.
- Non-high temperature resistant metallic containers for food and beverages are not allowed during cooking.
- Do not place any of the following materials in the appliances: cardboard, plastic, paper, or anything similar

2.4 Care and cleaning

WARNING!

Risk of injury, fire or damage to the appliance.

- Before maintenance, switch off the appliance and disconnect the mains plug from the mains socket.
- Regularly clean the appliance to prevent the deterioration of the surface material.
- Do not allow food spills or cleaner residue to accumulate on door sealing surfaces.
- Remaining fat or food in the appliance can cause smoke/fire, particularly on the heating element.
- Clean the appliance with a moist soft cloth. Only use neutral detergents. Do not use abrasive products, abrasive cleaning pads, solvents, or metal objects.

2.5 Disposal

WARNING!

Risk of injury or suffocation.

- Disconnect the appliance from the mains supply.
- Cut off the mains cable and discard it.

3. PRODUCT DESCRIPTION

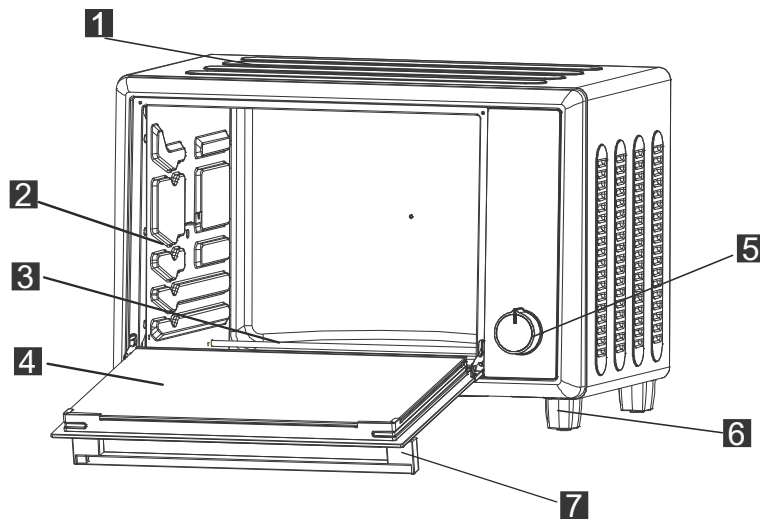

- 1** Housing
- 2** Inner cavity
- 3** Heating element
- 4** Glass door
- 5** Timer Knob
- 6** Support foot
- 7** Door handle

4. ACCESSORIES

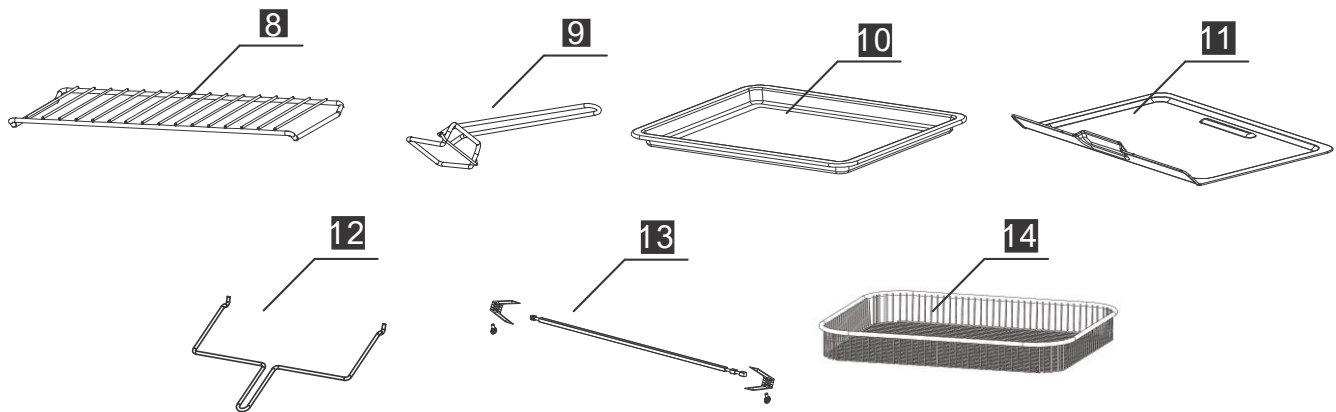

- 8** Grill rack
- 9** Tray picker
- 10** Enamel coating bake
- 11** Crumb tray
- 12** Rotisserie handle
- 13** Rotisserie fork
- 14** Air Fry basket

5. HOW TO USE

5.1 A Short power supply cord is provided to reduce the risks resulting from becoming entangled in or tripping over a longer cord .

- The electric rating of the extension cord should be at least as great as the electrical rating of the appliance.
- An extension cord with the power cord must be arranged so that it will not drape over the countertop or table top where they can be pulled on by children or tripped over accidentally .
- if the supply cord is damaged, it must be replaced by the manufacturer or its service agent ,or a similarly qualified person in order to avoid a hazard.

5.3 Operating instruction control panel



5.2 PREPARING FOR USE

- Unpack the unit
- Check the contents against the accessories list.
- Select a suitable position for the unit on a flat surface close to a power socket but away from a heat producing appliance or areas where cooking grease or water may splatter onto it.
- Plug into a suitable power outlet.
We recommend that you run it at MAX temperature for approximately 15 minutes to eliminate any packing oil that may remain after shipping.

DISPLAY WINDOW

Shows set time or temperature and oven function.



1. Start

Press this button to START the oven.



2.

Press this button once to STOP the oven. Press button twice to CLEAR oven current settings. Press button and hold for 3 seconds to activate/deactivate CHILD LOCK.



3.

Press this button to select Top Heat + Bottom Heat + Convection function.



4.

Press this button to select Top Heat + Convection function.



5.

Press this button to select Airfry function.



6.

Press this button to select Top Heat + Bottom Heat function.



7.

Press this button to select Bottom Heat function



8.

Press this button to select Top Heat + Bottom Heat + Convection + Rotisserie function.



9.

Press button to toggle between Timer and Temperature setting. Timer range is 1---480minutes, temperature range is 40---230°C.

10.

Press button to select various auto cooking menus shown on the display window.



11.

Press this button will toggle on/off light

OPERATION INSTRUCTIONS (show on DISPLAY WINDOW)



Temperature display, from 40°C-230°C, when in preheat phase, the "Preheat Indicator" will be blinking.



Timer display, from 1---480 minutes

1. The display range of the baking time is: 1-480 minutes, and the screen display format is 0:00, •hours: minutes".

For example, 55 minutes is displayed as 0:55; 65 minutes is displayed as 1:05.

2. When the oven is not working, if no operation is performed within five minutes, the oven will automatically enter the clock display.

Press and hold the clock button for 3 seconds to set the clock. The setting is 1 Minutes/ steps increase or decrease.



3. Warm

This is a selection under AUTO cook menu using upper + lower heating at 40°C for 50 minutes.

Note: the reference weight of the baked food (dough) is around 0.5-1kg.



4. Cookie

This is a selection under AUTO cook menu using upper + lower heating at 160°C for 30 minutes.

Note: the reference diameter is around 4 cm/pc, total 16 pieces.



5. Cake

This is a selection under AUTO cook menu using upper + lower heating at 160°C for 45 minutes.

Note: the reference size is around 8 inches.



6. Tarte

This is a selection under AUTO cook menu using upper + lower heating at 190°C for 25 minutes.

Note: the reference weight is around 50g and is about 6 cm in diameter, total 12-15 pieces.



7. Bread

This is a selection under AUTO cook menu using upper + lower heating at 170°C for 18 minutes.

Note: the reference amount is around 8-10 pieces.



9. Potato

This is a selection under AUTO cook menu using upper + lower heating at 200°C for 70 minutes.

Note: the reference weight of potato is around 0.16 kg/piece, total 8 pieces (total weight is 1-1.5 kg).



10. Wing

This is a selection under AUTO cook menu using upper + lower heating + convection at 210°C for 20 minutes.

Note: the reference weight is around 0.045 kg/piece, total 18 pieces (total weight is 0.5-1 kg).



11. Chicken

This is a selection under AUTO cook menu using upper + lower heating + Rotisserie + Convection at 220°C for 60 minutes.

Note: the reference weight is around 1.5-2 kg a piece.



12. Meat

This is a selection under AUTO cook menu using upper + lower heating + convection at 210°C for 20 minutes.

Note: the reference weight is around 0.15 kg/piece, thickness is about 1-2 cm, and amount is 2 pcs.



13. Fish

This is a selection under AUTO cook menu using upper + lower heating + convection at 210°C for 30 minutes.

Note: the reference weight is around 0.03-0.06 kg/piece.







14.

Press this button, then oven start work activate Child Lock. When Child Lock is on, to deactivate Child Lock, press and hold STOP for 3s.

Note:



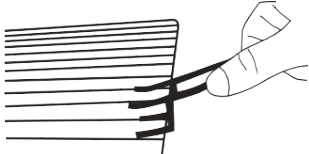

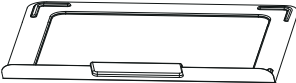
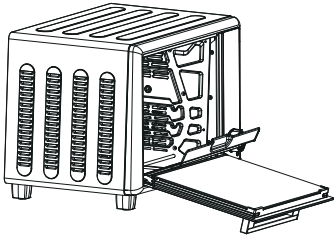
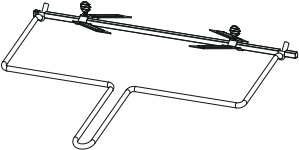
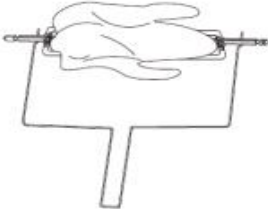
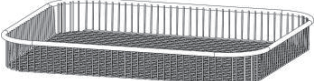
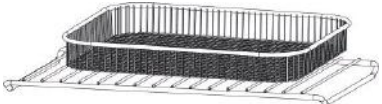
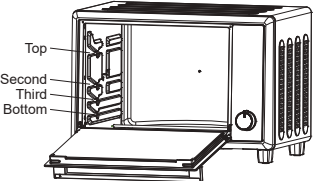





1. The setting of the auto cooking is the recommended baking temperature and time, which may vary depending on the type, temperature, quantity, weight, and container of the ingredients. So please adjust according to the actual ingredients and needs.
2. For better cooking effect, please do not use a bake tray under the roast chicken or add fruits and vegetables to block heat.
3. The auto menu is only suitable for designated foods, and it is not recommended to cook multiple foods together.
4. There may be some discrepancy between the set temperature and the actual temperature.

USING THE ACCESSORIES

Accessories	Description	How to use
 <p data-bbox="161 461 443 488">Enamel coating bake tray</p>	<p data-bbox="504 309 916 389">Use the tray to roast chicken, Hamburg steak, gratin, sponge cake, or almost all other oven-cooked food.</p>	 <p data-bbox="979 479 1318 560">When the tray or rack is hot, please use tray picker to take the tray out from the oven.</p>
 <p data-bbox="252 775 357 801">Grill rack</p>	<p data-bbox="504 658 922 712">Use grill rack to bake potato, dry food etc.</p>	
 <p data-bbox="161 990 443 1061">Enamel coating bake tray and grill rack</p>	<p data-bbox="504 887 906 967">Use bake tray and grill rack together for food which has water or oil dripping.</p>	
 <p data-bbox="233 1240 373 1267">Crumb Tray</p>	<p data-bbox="504 1178 928 1236">Use the crumb tray to hold bread crumbs, dirties during cooking.</p>	
	<p data-bbox="504 1433 928 1487">Use Rotisserie handle totake out the rotisserie rod.</p>	
 <p data-bbox="223 1769 379 1796">Air Fry basket</p>	<p data-bbox="504 1639 922 1720">When use the AIRFRY function for cooking, put the AIRFRY basket upon to the grill rack.</p>	
 <p data-bbox="210 2074 357 2101">Tray support</p>	<p data-bbox="504 1877 928 1957">You can put the tray or grill rack at the middle shelf position according to the food you want to cook.</p>	<p data-bbox="963 1877 1388 2011">When making macaroni gratin and you want to have the top part cooked the most, use the top or the second rack support. For roasting a chicken use the third rack support.</p>

COOKING RECIPES

EOT4022XFDG

Menu	Weights/ Amount	Temperature setting (°C)	Time (min.)	Food tray position	Function selection
Warm	0.5-1KG	40°C	50	Middle	 Warm
cookies	16 pcs (about 4cm cm/pc)	160°C	30	Middle	 Cookie
Cake	1pc (8 Inches)	160°C	45	Middle	 Cake
Tarte	12-15 pcs (about 6cm in diameter)	190°C	25	Middle	 Tarte
Bread	8-10 pcs	170°C	18	Middle	 Bread
Pizza	1pc (11 or 12 Inches)	180°C	20	Middle	 Pizza
Potato	8pcs (1-1.5 KG)	200°C	70	Middle	 Potato
Chicken wings	18pcs (0.5-1 KG)	210°C	20	Middle	 Wing
Chicken	Whole chicken (1.5-2 KG/pc)	220°C	60	Rotisserie position	 Chicken
Meat	2 pcs (1-2cm thickness, about 150g/pcs)	210°C	20	Middle	 Meat
Fish	1pcs (300-600g)	210°C	30	Middle	 Fish
Toast	6 pcs (10cm*10cm*1cm)	230°C	8-9	Middle	Bottom + Top Heating
Cup cake	15 pcs (7cm in diameter, about 70% full)	180°C	30-33	Middle	Bottom + Top Heating
Pineapple cake	16 pcs (5cm*3.5cm*2.5cm)	180°C	23-25	Middle	Bottom + Top Heating
Moon cake	12 pcs (about 80g/pcs)	180°C	23-25	Middle	Bottom + Top Heating
Hamburger	6 pcs	230°C	5-6	Middle	Bottom + Top Heating
Chicken wings	20pcs (300-800g)	200°C	30-35	Middle	Airfry function
Chicken thigh	10 pcs (1-1.5 KG)	200°C	35-40	Middle	Airfry function
French fries	300-800g	200°C	23-25	Middle	Airfry function
Chicken nugget	300-800g	200°C	23-25	Middle	Airfry function
Potato	8pcs (1-1.5 KG)	180°C	40-45	Middle	Airfry function
Seafood	more than 20pcs	200°C	20-25	Middle	Bottom + Top Heating
Vegetables /mushroom	more than 20pcs	180°C	20-25	Middle	Bottom + Top Heating

*Note: Cooking time need to be adjusted if volume/ quantity is more than recommend recipes.

ACCESSORIES

- **Wire rack**- supports casserole dishes and general cooking pans.
- **Bake tray** - for baking cookies, cakes etc. and also for collecting excess fats and juices.
- **Tray handle** - use this accessory to remove bake tray when hot.
- **Air fry basket** - When use the AIRFRY function for cooking, put the AIRFRY basket upon to the grill rack.
Note: can not cook the food which becomes soft after cooking, such as potatoes and sweet potatoes.

- **Rotisserie fork** – includes rotisserie rod x 1, rotisserie fork x 2, screw x 2. Insert the rotisserie rod into the chicken. Then secure the rod with the rotisserie forks with the pointed ends of the forks facing the center of the rod. Fasten the screws to tighten the forks.

Note: the rotisserie kit can carry food up to 3kg.

Insert the rod (rounded edge end) into the slot on the right of the oven, then rest the other end of the rod (squared edge end) on the catch on the left

- **Crumb Tray** - Use the crumb tray to hold bread / oil crumbs, dirties during cooking.

BAKE TRAY POSITIONING

This oven can bake breakfast (bread, cake and steam cake), as well as dishes (roast pork, spare ribs, fish, chicken, goose, duck, peanuts, etc) with the perfection in colour, taste and aroma. While cooking large piece of food, change position of the tray in order to allow the food to be baked evenly.

- The bake tray can be adjusted to 3 different positions according to the food you want to cook.

Note: it may be necessary to change the bake tray to a lower position if the surface is too brown or change it to a higher position if the base is browning.

MAINTENANCE INSTRUCTIONS

ALWAYS UNPLUG OVEN AND ALLOW TO COOL BEFORE CLEANING

- If desired, wipe walls with damp sponge, cloth or nylon scouring pad, and mild detergent. **DO NOT USE STEEL WOOL SCOURING PADS OR ABRASIVE CLEANERS OR SCRAPE WALLS WITH METAL UTENSILS, AS THIS MAY DAMAGE THE INTERIOR.**
- Wash all accessories in warm soapy water. Wipe the door clean with a damp sponge and wipe dry with a paper or cloth towel. Clean exterior with damp sponge. **DO NOT USE AN ABRASIVE CLEANER AS IT MAY DAMAGE THE EXTERIOR FINISH.**
- **DO NOT USE AN ABRASIVE CLEANER OR STEEL WOOL SCOURING PAD ON DRIP PAN, AS IT MAY DAMAGE THE FINISH.**
- **DRY ALL PARTS AND SURFACES THOROUGHLY PRIOR TO PLUGGING OVEN IN AND USING.**
- This appliance requires little maintenance. It contains no user serviceable parts. Do not try to repair it yourself. Contact a qualified appliance repair technician if the product requires servicing.

CLEANING INSTRUCTIONS

1. Always unplug and allow to cool completely before cleaning or moving.
2. Clean the Food Pan, Wire Rack, Food Pan handle and Crumb Tray after each use. The Crumb must be in position before using.
3. Clean the interior of Electric Oven and all removable parts with a mild non-abrasive cleaner and a plastic scouring pad after each use. Rinse and dry thoroughly. Do not rub too hard as the interior surface of the oven can be scratched.
4. Clean the Glass Oven Door and Electric Oven exterior with glass cleaner or mild detergent and a damp cloth or plastic scouring pad. Do not use an abrasive cleaner or pad as they might scratch the finish.
5. Rinse and dry thoroughly with a clean cloth. Allow to dry before closing Glass Door.
6. This appliance requires almost no maintenance, and it contains no user-serviceable parts.
7. Do not try to repair it yourself. If the product requires service, please contact a qualified electrical service technician.

TO STORE

Unplug unit, allow to cool, and clean before storing. Store Electric Oven in its box in a clean, dry place. Never store appliance while it is hot or still plugged in. Never wrap cord tightly around the appliance. Do not put any stress on the cord where it enters the unit, as it could cause the cord to fray and break.

NTC fault prompt description

1. In the temperature position of the digital screen, if the character "E1" appears, the buzzer will beep three times, indicating that the upper NTC is open, and the character "E2" appears, and the buzzer will beep three times, indicating that the upper NTC is short-circuited, and "E3" appears. Characters, the buzzer will beep three times (for sound requirements, please refer to the attached sound file), it means that the NTC is open, and the character "E4" appears, and the buzzer will beep three times, which means that the NTC is short-circuited.
2. When the "E1" and "E3" prompts appear, check whether the NTC port is loose or poorly connected. When the "E2" and "E4" prompts appear, check whether the NTC port or line is short-circuited.

Disposal

Disposal

Packaging materials

The packaging materials are environmentally friendly and can be recycled. The plastic components are identified by markings, e.g. >PE<, >PS<, etc. Please dispose the packaging materials in the appropriate container at the community waste disposal facilities.

Old appliance



The symbol  on the product or on its packaging indicates that this product may not be treated as household waste. Instead it shall be handed over to the applicable collection point for the recycling of electrical and electronic equipment. By ensuring this product is disposed of correctly, you will help prevent potential negative consequences for the environment and human health, which could otherwise be caused by inappropriate waste handling of this product. For more detailed information about recycling of this product, please contact your local city office, your household waste disposal service or the shop where you purchased the product.

SPECIFICATION

Specs/ Models	EOT4022XFDG
Power supply	220-240V ~50-60Hz
Power consumption	2250W
Capacity	40.0L
Temperature Settings	90°C - 230°C
Timer	480mins
Net weight (approx.)	11.0Kg
Power cord length	0.8 m
Unit Dimension (W x D x H) mm	528X400X358mm
Carton Dimension (W x D x H) mm	579X460X413mm

Consumer Care Center

<p>台灣 新加坡商伊萊克斯股份有限公司台灣分公司 22065新北市板橋區縣民大道二段68號9F 免付費客服專線: 0800-888-259 傳真: 886-2-8964-5269 電郵: service.tw@electrolux.com 網站: www.electrolux.com.tw</p>	<p>Hongkong Service Hotline: (+852) 3193 9888 OCH Electrical Appliances Services Centre 5/F, OCH Building, 20 Kai Cheung Road, Kowloon Bay, Hong Kong</p>
<p>Indonesia Hotline service: 08041119999 PT. Electrolux Indonesia Electrolux Building Jl.Abdul Muis No.34, Petojo Selatan, Gambir Jakarta Pusat 10160 Email:customercare@electrolux.co.id SMS & WA: 0812.8088.8863</p>	<p>Singapore Consumer Care Center Tel: (+65) 6727 3699 Electrolux SEA Pte Ltd 351 Braddell Road, #01-04 Singapore 579713 Office Fax: (+65) 6727 3611 Email : customer-care.sin@electrolux.com</p>
<p>Malaysia Consumer Care Center Tel: 1300-88-11-22 Electrolux Home Appliances Sdn. Bhd. Corporate Office Address: Unit T2-7, 7th Floor, Tower 2, PJ33, No. 3, Jalan Semangat, Seksyen 13, 46200 Petaling Jaya, Selangor. Office Tel : (+60 3) 7843 5999 Office Fax : (+60 3) 7955 5511 Consumer Care Center Address: Lot C6, No. 28,Jalan 15/22, Taman Perindustrian Tiong Nam,40200 Shah Alam, Selangor Consumer Care Center Fax : (+60 3) 5524 2521 Email : malaysia.customercare@electrolux.com</p>	<p>Philippines Consumer Care Center Toll Free : 1-800-10-845-CARE(2273) Consumer Care Hotline : (+63 2) 845-CARE(2273) Electrolux Philippines, Inc. Unit B 12F Cyber Sigma Bldg,Lawton Avenue, McKinley West,Taguig, Philippines 1634 Trunkline: +63 2 737- 4757 Website : www.electrolux.com.ph Email : wecare@electrolux.com</p>
<p>Thailand Consumer Care Tel : (+66 2) 725 9000 Electrolux Thailand Co., Ltd. Electrolux Building 14th Floor 1910 New Phetchaburi Road, Bangkok, Huai Khwang, Bangkok 10310 Office Tel : (+66 2) 7259100 Office Fax : (+66 2) 7259299 Email : customercarethai@electrolux.com</p>	<p>Vietnam Consumer Care Center Toll Free: 1800-58-88-99 Tel: (+84 28) 3910 5465 Electrolux Vietnam Ltd. Floor 9th, A&B Tower 76 Le Lai Street - Ben Thanh Ward - District 1 Ho Chi Minh City , Vietnam Office Tel: (+84 28) 3910 5465 Office Fax: (+84 28) 3910 5470 Email: vnccare@electrolux.com</p>

