

EGT7836BEP  
EHG8250BEP  
EHG9350BEP  
EHG9350BE

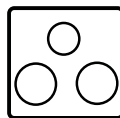

EN Gas Cooktop

Installation & User manual

## Enjoy peace of mind. Register your appliance today.

Stay updated on better living services,  
safety notices and shop for accessories.

- 1. Open the camera app on your smartphone and point at the QR code to scan.**

Product Registration QR code is located on the top surface or underside of your appliance.

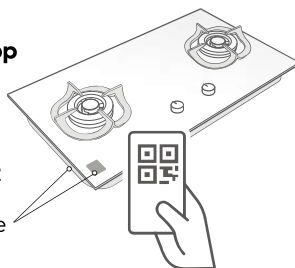

- 2. Tap the notification or link to open the registration form.**
- 3. Complete your details and enjoy peace of mind.**



**Electrolux**

<b>Safety instructions</b> .....	<b>3</b>
<b>Parts description</b> .....	<b>5</b>
<b>Installation instructions</b> .....	<b>7</b>
Installation procedure .....	8
Gas connection.....	8
<b>Operation</b> .....	<b>11</b>
Ignition burners.....	11
Using the hob correctly.....	11
<b>Maintenance and care</b> .....	<b>12</b>
Glass top .....	12
Burner caps & crowns .....	12
<b>What to do if</b> .....	<b>13</b>
<b>Technical specifications</b> .....	<b>14</b>
<b>Warranty conditions</b> .....	<b>15</b>

Dear customer,

Thank you for purchasing an Electrolux cooktop.

You've chosen a product that brings with it decades of professional experience and innovation. Ingenious and stylish, it has been designed with you in mind. So whenever you use it, you can be safe in the knowledge that you'll get great results every time.

Welcome to Electrolux.

## Safety instructions

- Do not use gas other than that which is specified on the label attached.
- Do not place anything, e.g. flame tamer, asbestos mat, between pan and pan support as serious damage to the appliance may result. (Fig 1)
- Do not remove the pan support and enclose the burner with a wok stand not supplied by Electrolux as this will concentrate the flame and deflect the heat onto the top plate. (Fig 2)
- Do not use large pots or heavy weights which can bend the pan support or deflect the flame onto the top plate. (Fig 3)
- Locate pan centrally over burner so that it is stable and does not overheat the appliance. (Fig 4)
- Use only wok support supplied or recommended by the manufacturer of the appliance. (Fig 5)
- Wok support to be used for wok and other trivets for flat bottom pot.
- The unit is to be used for cooking only. It shall not be used for other purposes, for example room heating. Do not dry towels, clothes, etc., over it. If this is done, there is danger of fire.
- If a gas leak is found, close stopcock, open up all windows and call your dealer. Do refrain from turning an electric switch on or off, lighting a match, smoking or using a lighter.
- Do not use vinyl gas hose. It is liable to be softened by heat. Use only a rubber hose.
- Be sure to turn off the ignition knob and regulator of the cylinder after use.
- Avoid touching the burner, pan stand etc., immediately after use. Otherwise you will get burnt.
- Ensure that the rubber hose does not touch any part of the unit or lies underneath it.
- Connect the rubber hose to the gas inlet and fasten it with a hose clamp.
- The pan stand leg nearest to the flame will have discoloration after use. Such phenomenon is normal.



### WARNING

- **In the event of the burner flames being accidentally extinguished, turn off the burner control knob and do not attempt to re-ignite the burner for at least 1 minute.**
- **For burner fitted with a flame supervision device, if after 15 seconds of ignition operation the burner has not lit, stop operating the device and open the compartment door and wait at least 1 minute before attempting a further ignition of the burner.**
- **If nozzle holes are blocked, use a thin wire or pin to pierce and clean the nozzle holes.**

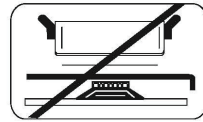

Fig. 1

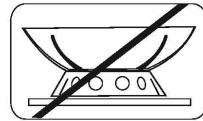

Fig. 2

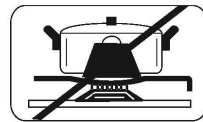

Fig. 3

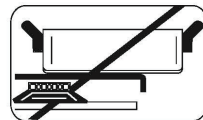

Fig. 4

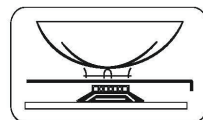
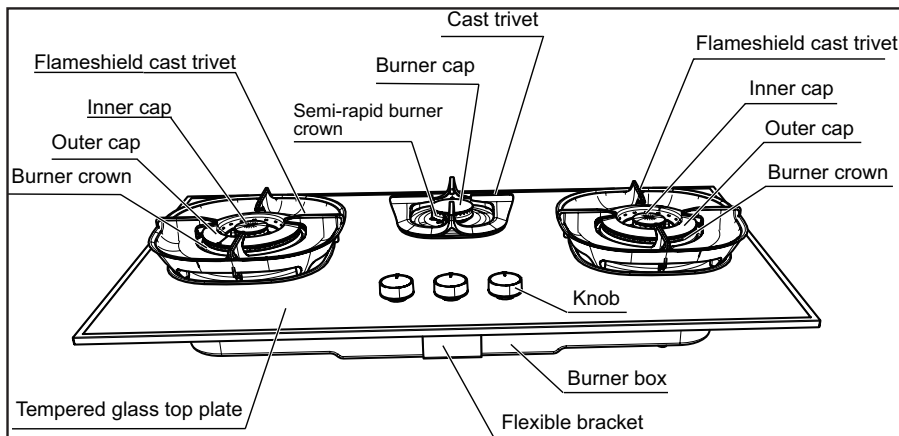

Fig. 5

- **CAUTION:** The use of a gas cooking appliance results in the production of heat, moisture and products of combustion in the room in which it is installed. Ensure that the kitchen is well ventilated especially when the appliance is in use.
- Prolonged intensive use of the appliance may require additional ventilation, for example the increasing of mechanical ventilation where present, additional ventilation to safely remove the products of combustion to outside (external) air whilst also providing room air changes with additional ventilation.
- Consult a professional before installation of the additional ventilation.

## Parts description

### EHG9350BEP/ EHG9350BE



### EHG8250BEP

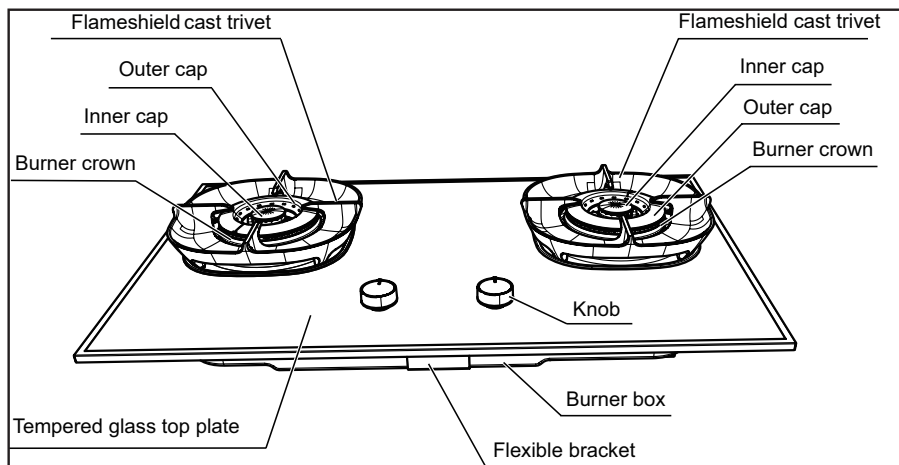

#### Flameshield Trivet

The Flameshield Trivet reduces heat loss to deliver more intense heat to the cooking process, for effortlessly perfecting dishes from soups to stir-fries. The curved trivet profile works like cradling a candle, cupping the flame and channelling the energy directly onto the bottom of the pan. By directly heat more efficiently, our FlameShield Trivet cooktops cook faster and consume less energy than previous models, helping you to achieve quick, tasty meals while lowering your energy bills over time.

## EGT7836BEP

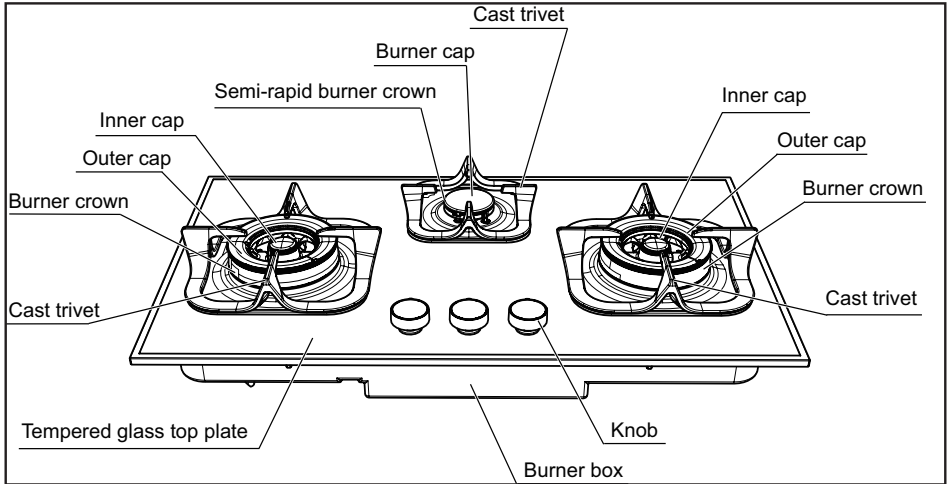
**The Class of the appliance: Class 3**

These instructions are only valid if the country symbol appears on the appliance.

If the symbol does not appear on the appliance, it is necessary to refer to the technical instructions which will provide the necessary instructions concerning modification of the appliance to the conditions of use of the country.

Prior to installation, ensure that the local distribution conditions (nature of the gas and gas pressure) and the adjustment of the appliance are compatible

The adjustment conditions for this appliance are stated on the label (or data plate).

This appliance is not connected to a combustion products evacuation device. It shall be installed and connected in accordance with current installation regulations.

Particular attention shall be given to the relevant requirements regarding ventilation.

Avoid using of cooking vessels on the hotplate that overlap its edges.

The use of inappropriate hob guards can cause accidents.

Hob guards cannot be used.

The use of a gas cooking appliance results in the production of heat, moisture and products of combustion in the room in which it is installed.

Ensure that the kitchen is well ventilated, especially when the appliance is in use: keep natural ventilation holes open or install a mechanical ventilation device (mechanical extractor hood).

Prolonged intensive use of the appliance may call for additional ventilation, for example opening of a window, or more effective ventilation, for example increasing the level of mechanical ventilation where present.

 **CAUTION:**

In case of hotplate glass breakage:

- immediately shut off all burners and any electrical heating element and isolate the appliance from the power supply.
- do not touch the appliance surface,
- do not use the appliance.

## Installation instructions

- Have the installer show you the location of the gas shut-off valve and how to shut it off in emergency.
- Be certain all packing materials are removed from the hob before operating to prevent fire or smoke damage that could be caused by the presence of these materials.
- Observe all instructions for minimum clearance to any combustible surfaces. These should be in accordance with information on the rating plate and with national fire laws.
- If the hob is installed near windows, proper precautions should be taken to prevent curtains from blowing over burners creating a FIRE HAZARD.
- When choosing a location for this hob consider, availability and position of gas and electric supply paths.
- Any openings around gas and electric service outlets shall be closed at the time of installation.
- Do not install another hob next to this unit.
- The underside of the hob must be checked to ensure that there are no projections which might foul the hob. Make sure that the countertop is solidly supported and can withstand the weight of the hob.
- Check that the cabinet is leveled from side to side and from front to back in its installed position.
- Cabinet ventilation can be improved by the provision of air holes to the cabinet. Care should be taken to ensure that ventilation holes are not obstructed.
- When fitting a vent hood above the hob, refer to the manufacturer own installations relating to that product. However as a general rule, a minimum clear vertical distance of 750mm (30") should be maintained between the cooktop and the underside of any cupboard, wall unit or vent. (Fig 6)
- Any cabinet installed above the cooktop must not be greater than 325mm (13") deep. (Fig 6)
- The edge of the hob must have a minimum

distance of 55mm from the rear wall. (Fig 6)

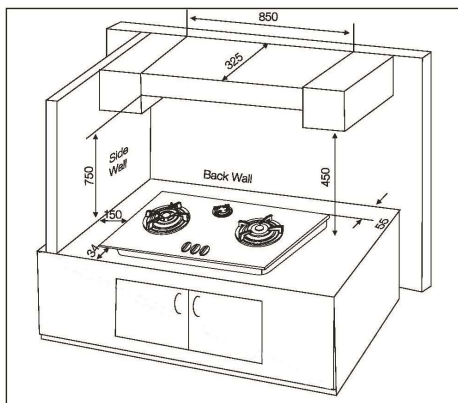

Fig. 6 (in mm)

If clearance between side/back walls and periphery of the burner is less than 200mm, the walls must be protected with a non-combustible material. The protection must extend a minimum distance of 450mm above the burner. Horizontal surfaces less than 750mm vertically above the cooktop must also be protected.

### BATTERY COMPARTMENT

1. When the battery is exhausted; or the spark become weak, a new battery should be replaced.
2. The battery compartment is located as shown in the diagram. Please place the battery in the correct polarity as shown.

**Warning:** Please take out the battery if not use for a long time.

EGT7836BEP:

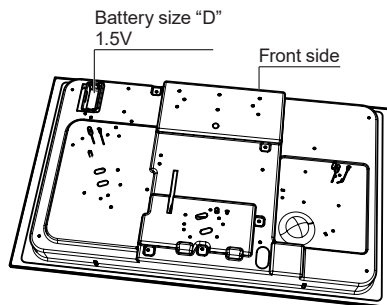

EHG8250BEP/EHG9350BEP/EHG9350BE:

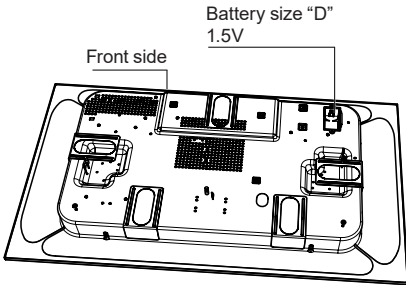

## Installation procedure

- Before installing the appliance, check that the location provides the required clearances from combustible materials and check if necessary to provide protection to adjacent surfaces as required by the regulation. Make provision for the gas supply to be connected to the location.
- Cut the opening in the bench top by the cardboard - template given in the hob packing or to the dimensions shown in Fig 7.
- Remove the hob from the carton.
- Install the hob in the cut-out (Fig 7).
- Connect gas supply to inlet of hob. Turn the gas on and check for leaks using soap solution and brush around all the joints and connection.
- Test the appliance; depress the control knob and turn to full flame setting to activate the electric igniter. The burner will ignite. Adjust control knob to the desired setting. On initial usage you may have to repeat this ignition function several times (to allow air to be purged from the gas supply system). No adjustment should be necessary. If any problem occurs, refer to the servicing instructions or the troubleshooting chart.
- Ensure the manual is left with the user. If any of the above procedures do not produce satisfactory results, the agent service department should be consulted for more specialized assistance.
- This gas hob has been tested for operating on town gas pressure up to 31 mbar.

## Gas connection

- The supply hose must be visible for its entire length (max. one meter) and must be secured with a hose clamp X (Fig 8). The sealing washer must be fitted.



## IMPORTANT SAFETY INSTRUCTIONS:

Upon completion of gas installation connections, it is compulsory to check for gas leakage at the joint. (Soap test)

## Installation of LPG cooker and cylinder (only for EHG9350BE)

### 1. Pre-installation checks

The following steps should be taken prior to installation:

- Check that there is good ventilation in the work area before starting the installation process.
- Check the area for combustible material prior to installation. Remove any combustible material from the immediate area, where possible.
- Check that the cookers and other connected accessories have the appropriate safety marks. Components that do not possess approved safety marks should be flagged for replacement.

### 2. Selection of parts

Only approved low pressure regulators as specified in SS 281 shall be used.

The nozzle and gasket shall be supplied together to ensure a correct fit. The dimensions of the flexible rubber tubing used shall match the nozzle as specified in SS 233.

### 3. 5-point visual safety check

The installer shall perform the 5-point visual safety check whenever an installation is made. The 5-points visual safety check covers the following:

- For regulators:
  - check the regulator for a valid safety mark. Replace the regulator if a valid safety mark is not found on it.
  - check the expiry date of the regulator.



## 9 Installation instructions

- Replace the regulator if it has expired.
- iii. perform a visual inspection to identify any signs of wear and tear or deterioration in the material. Replace the regulator if there is sufficient damage to indicate a possible failure of function.
  - b. For flexible rubber tubing:
    - i. check the flexible rubber tubing for a valid safety mark and expiry date. Replace the rubber tubing if the safety mark and/or expiry date are not visible on it.
    - ii. check the expiry date of the rubber tubing. Replace the rubber tubing if it has expired.
    - iii. perform a visual inspection along the entire length and on all sides of the rubber tubing, especially sections that are bent. Identify any signs of wear and tear or deterioration such as minor cracks in the rubber. Replace the rubber tubing if any material degradation is detected.
  - c. For cylinder, check and ensure that the cylinders are stored upright. Storing or using the cylinders tilted, sideways or upside down affects how the gas is released into the flexible rubber tubing and is unsafe.
  - d. For hose clamps:
    - i. check the fit of the hose clamp on the flexible rubber tubing. The hose clamp shall be in close contact with the flexible rubber tubing for its entire circumference.
    - ii. perform a visual inspection for indents or cuts on the flexible rubber tubing as these indicate that the hose clamp is too tight. Adjust the tension on the hose clamp to prevent overtightening.
  - e. For joint connections:
    - i. check that an appropriate gasket is placed between connections.
    - ii. with parallel threads, do not use sealing tape.
    - iii. perform a visual inspection of all joint connections for signs of wear and tear or poor connections. Reconnect joints if the connections appear to be loose. Replace any damaged or otherwise faulty joint components.
  - iv. perform leak tests by applying a soap

solution or leak detection fluid to the joint areas. Bubbles can appear at the joint areas where there is a leak. If a leak is detected, tighten the relevant joints and perform the test again. If bubbles reappear, replace the joint components. Allow 3 to 4 min for the bubbles to form. Complete leak tests before installation of a gas hob into cabinets (for new installations).

### 4. Post-installation checks

The installer shall carry out the following checks for post-installation:

- a. Check the tension on the flexible rubber tubing prior to reinstating the cylinder to the cabinet. Ensure that the placement of the cylinder does not add unnecessary tension to the connections or flexible rubber tubing. Once installed, check that the flexible rubber tubing is not bent at an acute angle and that there are no kinks in the flexible rubber tubing.
- b. Brief the end-user on safety measures and precautions, including any upcoming expiry dates of replaceable components.
- c. Obtain the end-user's acknowledgment of their safety awareness after the briefing.

### 5. Training for installation

To ensure safety in installations, gas service workers shall be trained and qualified by the respective company on Clause 6 of this standard before they can commence installation works at the site. All gas service workers should read through the user/ installation manuals of the respective brand manufacturer before attempting to install or replace any LPG cookers and cylinders.

### Flexible connection

The supply hose must be visible for its entire length (max. one meter) and must be secured with a hose clamp X (Fig 8). The sealing washer must be fitted.

Model: EGT7836BEP

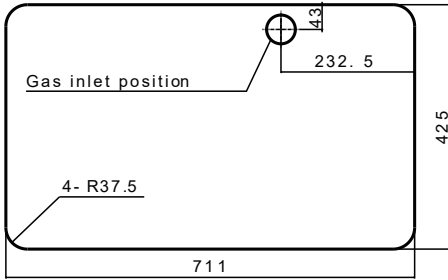

Fig. 7-1 (in mm)

**Flexi installation cut-out (EHG8250BEP/ EHG9350BEP/EHG9350BE)**

- The smaller burner (lower) box of this cooktop combined with the extended glass overhang, and flexible bracket makes installation into existing counter cut-outs easy without additional modification.
- For replacement purchase, ensure cutout size fall within the given dimension for the desired hob.
- Gas hobs should be secured properly with the flexible brackets provided to prevent it from moving in Fig 7-2.

Model	Cut-out Dimensions
EHG8250BEP	Width(630-765)*Depth(350-465) R50
EHG9350BEP/ EHG9350BE	Width(700-865)*Depth(405-480) R50



**Soap test procedure**

- Turn the burner controls off and turn on the gas supply.
- Apply soapy solution to each joint. (Fig. 8)
- Formation of bubbles indicates leakage and must be tightened.
- Repeat soap test.

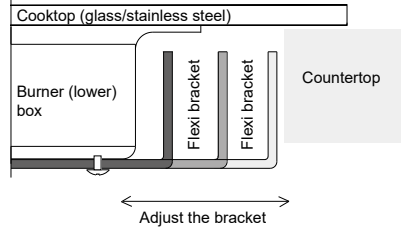
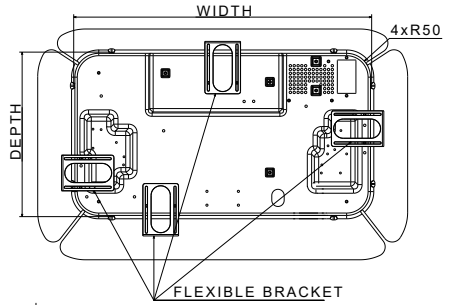

Fig. 7-2 (in mm)

Bench cut-out size viewed from front of bench, i.e. control panel at front. If clearance between side/back walls and periphery of the burner is less than 200mm, the walls must be protected with non-combustible material. The protection must extend a minimum distance of 450mm above the burner. Horizontal surfaces less than 750mm vertically above the hob must also be protected.

**WARNING:**

Check the data plate to ensure that the appliance is suitable for the available gas supply.

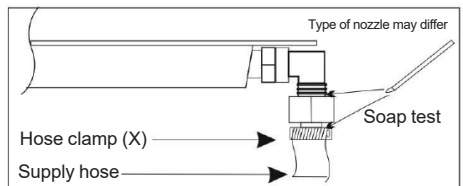

Fig. 8

## Operation

### Ignition burners

1. Check to make sure that the gas supply is accessible and set up with the necessary and appropriate fittings/connectors.
2. Turn all control knobs to OFF position.
3. This device is fitted with a safety tap to control the gas flow. When the dot on the knob lines up with the following symbols on the panel, these conditions prevail:

EGT7836BEP:

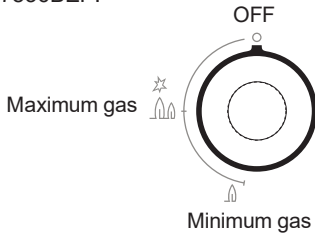

To turn off, rotate the knob to the right until you feel the tap's distinct click.

EHG8250BEP/EHG9350BEP/EHG9350BE:

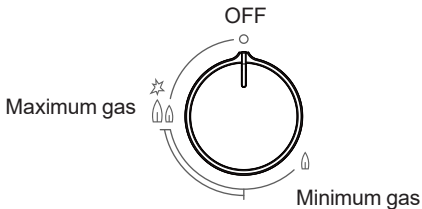

To turn off the gas, rotate the knob anticlockwise until you feel the distinct click on the knob and the indicator on the knob is pointing to "0".

4. To ignite, hold the knob and depress for several seconds, rotate it to the maximum gas flow position (  ). For models with thermocouple, keep the knob depressed for 5-8 seconds, otherwise the flame will extinguish.
5. If the burner does not light the first time, repeat step 4.
6. If the flame extinguishes suddenly, repeat step 4.
7. When using the unit again immediately after having once turned it off, wait for

about ten seconds before re-igniting.

8. Each burner has its own independent ignitor.
9. When the burner is lit, turn the knob to adjust the flame size according to your needs. This needs no depression of the knob.

For burner fitted with a flame supervision device, if after 15 seconds of ignition operation the burner has not lit, stop operating the device and wait at least 1 minute before attempting a further ignition of the burner.

### Using the hob correctly

- To ensure maximum burner efficiency, it is strongly recommended that you use only pots and pans with a bottom fitting the size of the burner used, so that the flame will not spread beyond the bottom of the vessel (Table 1).
- It is also advisable, as soon as the liquid starts boiling, to turn down the flame so that it will barely keep the liquid simmering.

Burner	Minimum Diameter	Maximum Diameter
Wok burner	120mm	280mm
Semi-rapid	120mm	260mm

Table 1

### Choice of burner

- A semi-rapid burner is for special low heat, simmering and slow cooking.
- A wok burner is for very fast heating using a wok or large pan.

### NOTE:

Remember that a wide-bottomed pan allows a faster cooking than a narrow one.

Always use pots which properly fit what you have to cook.

Particularly make sure that the pans are not too small for liquids, since these could easily overflow.

The pans should not be too large for a faster cooking.

You should use pans with the right diameter to fit the burner, in order to make the most out of it, thus reducing gas consumption as in Fig 12.

It is also advisable to cover any boiling casserole and as soon as the liquid starts to boil, lower the flame enough to keep the boiling point.

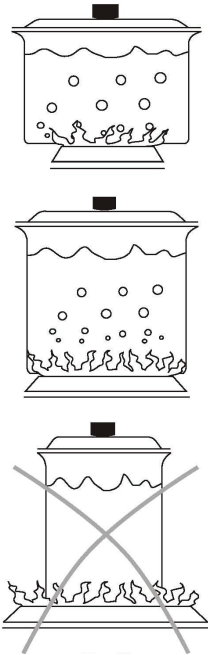

Fig. 12

## Maintenance and care

### Glass top

- Persistent stains may require vigorous rubbing with nylon scourer or creamed powder cleansers. Household enamel cleaners are available, follow the manufacturer instructions in their use. Harsh abrasive cleaners, powder cleaners, steel wool or wax polishes should not be used.
- Do not use the glass top as a work table.

### Burner caps & crowns

- These can all be lifted off and removed for separate cleaning.
- Ensure burner caps and crowns are thoroughly dried after cleaning or spillage.
- When cleaning the burner, ensure that all the flame ports, injector hole and other holes are free of any blockage. (Fig. 13&14)

EHG8250BEP/EHG9350BEP/EHG9350BE:

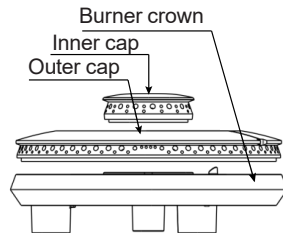

EGT7836BEP:

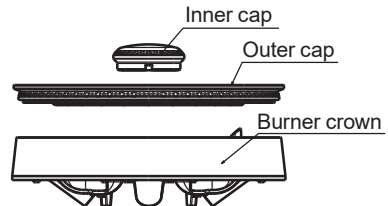
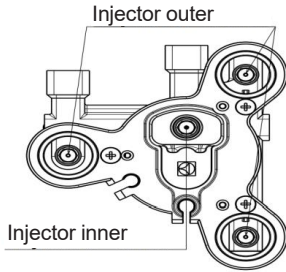

Fig. 13

- After cleaning, ensure the burner caps are reassembled properly into position.
- After cleaning service, when assembling the burner crown and caps, care must be taken to ensure the spark plug is not knocked. The spark plug will crack if knocked and may face risk with flame ignition problem.

### 13 What to do if

EHG8250BEP/EHG9350BEP/EHG9350BE:



**NOTE:**

When refitting the burner caps & crowns, ensure that they are correctly seated.

**! WARNING**

Do not spray aerosols in the vicinity of this hob while in operation. Some propellant gases can break down when heated and produce corrosive vapours which will attack some materials.

EGT7836BEP:

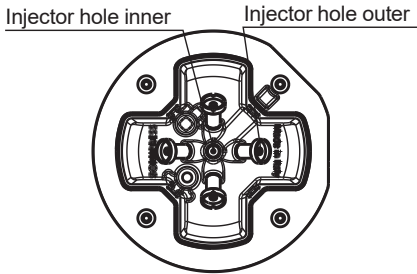

Articles which are made from flammable materials should not be stored in drawers or cupboards immediately below this hob.

Do not store articles within 50mm of the base.

Do not touch spark ignitor while lighting the burner.



Where this appliance is installed in a marine craft or in caravans, it shall not be used as a space heater.

Fig. 14

### What to do if

Problem	Possible cause	Remedy
Burner will not light...	Air in gas line Blockage in line Ignition not sparking Battery is flat Burner not fitted correctly	Purge gas line Trace back & clear Check lead & electrode Replace battery Fit burner in correct position
Burner lights back to injector...	Excessive lint up of burner mixing tube Excessive gas pressure	Remove & clean burner Check gas regulator pressure & adjust if necessary
Burner has explosive ignition...	Excessive gas pressure	Check gas regulator pressure & adjust if necessary
Ignitor not sparking...	Excessive electrode gap Ignitor connections loose Battery is flat	Check gap, and adjust so it is 4-5mm Check connections to ignitor, replace if faulty Change a new battery

## Technical specifications

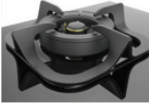
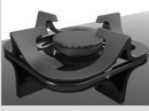
	Burner Description	Gas Type	Heat Input	Injector size (mm)	Gas Pressure	Model Name
	Triple-ring burner	TG	4.0 kW	1.53*3+1.28	11 mbar	EHG8250BEP/ EHG9350BEP
		LPG	5.2 kW	0.60*3+0.46	30 mbar	EHG9350BE
	Semi-rapid burner	LPG	2.0 kW	0.71	30 mbar	EHG9350BE
		TG	1.8 kW	1.84	11 mbar	EHG9350BEP
	Triple-ring burner	TG	4.0 kW	1.14*4+1.12	14 mbar	EGT7836BEP
	Semi-rapid burner	TG	1.8 kW	1.61	14 mbar	EGT7836BEP
Reduce rate	1.0 kW					
Gas connection	0.5 Inch straight thread (14 threads per inch)					
Battery	1.5V DC					

# Electrolux Warranty

We, Electrolux, undertake that if within warranty date of the purchase this Electrolux appliance or any part thereof is proved to be defective by reason only of faulty workmanship or materials, we will, at our option repair or replace the same FREE OF CHARGE for labour, materials or carriage on condition that:

- The appliance has been correctly installed and used only on the electricity supply stated on the rating plate.
- The appliance has been used for normal domestic purposes only, and in accordance with the manufacturer instructions.
- The appliance has not been serviced, maintained, repaired, taken apart or tampered with by any person not authorized by us.

All service work under this warranty must be undertaken by an authorized Electrolux Service Center. Any appliance or defective part replaced shall become the Company property. This warranty is in addition to your statutory and other legal rights. This warranty does not include maintenance, like cleaning of hood.

The manufacturer waives all liability for failure to observe the instructions for the appropriate installation, maintenance and use of the appliance.

## **Consumer Care Center**

Tel: (+65) 6727 3699 Electrolux Sales Office and Service  
Center

351 Braddell Road, #01-04

Singapore 579713

Email : [customer-care.sin@electrolux.com](mailto:customer-care.sin@electrolux.com)

305536626/A

