

CONTENTS

1. SAFETY INFORMATION.....	2
2. SAFETY INSTRUCTIONS.....	4
3. PRODUCT DESCRIPTION.....	6
4. BEFORE FIRST USE.....	7
5. DAILY USE.....	7
6. CLOCK FUNCTIONS.....	9
7. USING THE ACCESSORIES.....	10
8. ADDITIONAL FUNCTIONS.....	10
9. HINTS AND TIPS.....	11
10. CARE AND CLEANING.....	23
11. TROUBLESHOOTING.....	25
12. ENERGY EFFICIENCY.....	26

WE'RE THINKING OF YOU

Thank you for purchasing an Electrolux appliance. You've chosen a product that brings with it decades of professional experience and innovation. Ingenious and stylish, it has been designed with you in mind. So whenever you use it, you can be safe in the knowledge that you'll get great results every time.

Welcome to Electrolux.

Visit our website for:



Get usage advice, brochures, trouble shooter, service information:

www.electrolux.com



Register your product for better service:

www.registerelectrolux.com



Buy Accessories, Consumables and Original spare parts for your appliance:

www.electrolux.com/shop

CUSTOMER CARE AND SERVICE

Always use original spare parts.

When contacting our Authorised Service Centre, ensure that you have the following data available: Model, PNC, Serial Number.

The information can be found on the rating plate.

 Warning / Caution-Safety information

 General information and tips

 Environmental information

Subject to change without notice.

1. SAFETY INFORMATION

Before the installation and use of the appliance, carefully read the supplied instructions. The manufacturer is not

responsible if an incorrect installation and use causes injuries and damages. Always keep the instructions with the appliance for future reference.

1.1 Children and vulnerable people safety

- This appliance can be used by children aged from 8 years and above and persons with reduced physical, sensory or mental capabilities or lack of experience and knowledge if they have been given supervision or instruction concerning use of the appliance in a safe way and understand the hazards involved.
- Do not let children play with the appliance.
- Keep all packaging away from children.
- Keep children and pets away from the appliance when it operates or when it cools down. Accessible parts are hot.
- If the appliance has a child safety device, we recommend you activate it.
- Cleaning and user maintenance shall not be made by children without supervision.
- Children of less than 3 years should be kept away unless continuously supervised.

1.2 General Safety

- Only a qualified person must install this appliance and replace the cable.
- Internally the appliance becomes hot when in operation. Do not touch the heating elements that are in the appliance. Always use oven gloves to remove or put in accessories or ovenware.
- Before maintenance cut the power supply.
- Ensure that the appliance is switched off before replacing the lamp to avoid the possibility of electric shock.
- Do not use a steam cleaner to clean the appliance.
- Do not use harsh abrasive cleaners or sharp metal scrapers to clean the glass door since they can

scratch the surface, which may result in shattering of the glass.

- If the supply cord is damaged, it must be replaced by the manufacturer, its Authorised Service Centre or similarly qualified persons in order to avoid a hazard.
- To remove the shelf supports first pull the front of the shelf support and then the rear end away from the side walls. Install the shelf supports in the opposite sequence.

2. SAFETY INSTRUCTIONS

2.1 Installation



WARNING!

Only a qualified person must install this appliance.

- Remove all the packaging.
- Do not install or use a damaged appliance.
- Obey the installation instruction supplied with the appliance.
- Always be careful when you move the appliance because it is heavy. Always wear safety gloves.
- Do not pull the appliance by the handle.
- Keep the minimum distance from the other appliances and units.
- Make sure that the appliance is installed below and adjacent safe structures.
- The sides of the appliance must stay adjacent to appliances or to units with the same height.

2.2 Electrical connection



WARNING!

Risk of fire and electrical shock.

- All electrical connections should be made by a qualified electrician.
- The appliance must be earthed.
- Make sure that the electrical information on the rating plate agrees with the power supply. If not, contact an electrician.

- Always use a correctly installed shockproof socket.
- Do not use multi-plug adapters and extension cables.
- Make sure not to cause damage to the mains plug and to the mains cable. Should the mains cable need to be replaced, this must be carried out by our Authorised Service Centre.
- Do not let mains cables touch or come near the appliance door, especially when the door is hot.
- The shock protection of live and insulated parts must be fastened in such a way that it cannot be removed without tools.
- Connect the mains plug to the mains socket only at the end of the installation. Make sure that there is access to the mains plug after the installation.
- If the mains socket is loose, do not connect the mains plug.
- Do not pull the mains cable to disconnect the appliance. Always pull the mains plug.
- Use only correct isolation devices: line protecting cut-outs, fuses (screw type fuses removed from the holder), earth leakage trips and contactors.
- The electrical installation must have an isolation device which lets you disconnect the appliance from the mains at all poles. The isolation device must have a contact opening width of minimum 3 mm.
- This appliance complies with the E.E.C. Directives.

2.3 Use



WARNING!

Risk of injury, burns and electrical shock or explosion.

- Use this appliance in a household only.
- Do not change the specification of this appliance.
- Make sure that the ventilation openings are not blocked.
- Do not let the appliance stay unattended during operation.
- Deactivate the appliance after each use.
- Be careful when you open the appliance door while the appliance is in operation. Hot air can release.
- Do not operate the appliance with wet hands or when it has contact with water.
- Do not apply pressure on the open door.
- Do not use the appliance as a work surface or as a storage surface.
- Open the appliance door carefully. The use of ingredients with alcohol can cause a mixture of alcohol and air.
- Do not let sparks or open flames to come in contact with the appliance when you open the door.
- Do not put flammable products or items that are wet with flammable products in, near or on the appliance.



WARNING!

Risk of damage to the appliance.

- To prevent damage or discoloration to the enamel:
 - do not put ovenware or other objects in the appliance directly on the bottom.
 - do not put aluminium foil directly on the bottom of the appliance.
 - do not put water directly into the hot appliance.
 - do not keep moist dishes and food in the appliance after you finish the cooking.
 - be careful when you remove or install the accessories.

- Discoloration of the enamel has no effect on the performance of the appliance. It is not a defect in the sense of the warranty law.
- Use a deep pan for moist cakes. Fruit juices cause stains that can be permanent.
- This appliance is for cooking purposes only. It must not be used for other purposes, for example room heating.
- Always cook with the oven door closed.
- If the appliance is installed behind a furniture panel (e.g. a door) make sure the door is never closed when the appliance is in operation. Heat and moisture can build up behind a closed furniture panel and cause subsequent damage to the appliance, the housing unit or the floor. Do not close the furniture panel until the appliance has cooled down completely after use.

2.4 Care and cleaning



WARNING!

Risk of injury, fire, or damage to the appliance.

- Before maintenance, deactivate the appliance and disconnect the mains plug from the mains socket.
- Make sure the appliance is cold. There is the risk that the glass panels can break.
- Replace immediately the door glass panels when they are damaged. Contact the Authorised Service Centre.
- Be careful when you remove the door from the appliance. The door is heavy!
- Clean regularly the appliance to prevent the deterioration of the surface material.
- Remaining fat or food in the appliance can cause fire.
- Clean the appliance with a moist soft cloth. Only use neutral detergents. Do not use abrasive products, abrasive cleaning pads, solvents or metal objects.
- If you use an oven spray, obey the safety instructions on the packaging.

- Do not clean the catalytic enamel (if applicable) with any kind of detergent.

2.5 Internal light

- The type of light bulb or halogen lamp used for this appliance is only for household appliances. Do not use it for house lighting.



WARNING!
Risk of electrical shock.

- Before replacing the lamp, disconnect the appliance from the power supply.
- Only use lamps with the same specifications.

2.6 Disposal



WARNING!
Risk of injury or suffocation.

- Disconnect the appliance from the mains supply.
- Cut off the mains cable and discard it.
- Remove the door catch to prevent children and pets to get closed in the appliance.

2.7 Service

- To repair the appliance contact an Authorised Service Centre.
- Use original spare parts only.

3. PRODUCT DESCRIPTION

3.1 General overview

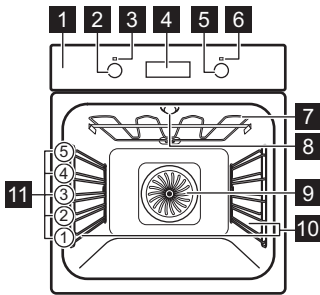

- 1** Control panel
- 2** Knob for the oven functions
- 3** Power lamp / symbol / indicator
- 4** Electronic programmer
- 5** Knob for the temperature
- 6** Temperature lamp / symbol / indicator
- 7** Heating element
- 8** Lamp
- 9** Fan
- 10** Shelf support, removable
- 11** Shelf positions

3.2 Accessories

Wire shelf

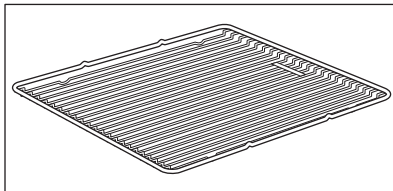

For cookware, cake tins, roasts.

Baking tray

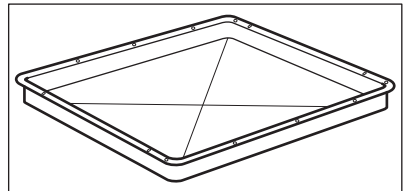

For cakes and biscuits.

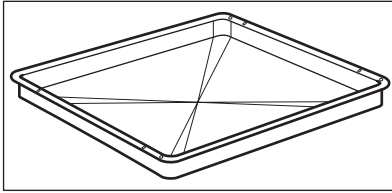
Grill- / Roasting pan

To bake and roast or as a pan to collect fat.

4. BEFORE FIRST USE



WARNING!
Refer to Safety chapters.

4.1 Initial Cleaning

Remove all accessories and removable shelf supports from the appliance.



Refer to "Care and cleaning" chapter.

Clean the appliance before first use. Put the accessories and the removable shelf supports back to their initial position.

4.2 Setting the time

You must set the time before you operate the oven.

The indicator for the Time of day function flashes when you connect the appliance

to the electrical supply, when there was a power cut or when the timer is not set.

Press the \oplus or \ominus button to set the correct time.

After approximately five seconds, the flashing stops and the display shows the time of day you set.

4.3 Changing the time



You cannot change the time of day if the Duration $| \rightarrow |$ or End $\rightarrow |$ function operates.

Press ⌚ again and again until the indicator for the Time of Day function flashes.

To set a new time, refer to "Setting the time".

5. DAILY USE



WARNING!
Refer to Safety chapters.

5.1 Retractable knobs

To use the appliance, press the control knob. The control knob comes out.

5.2 Activating and deactivating the appliance











It depends on the model if your appliance has knob symbols, indicators or lamps:

- The indicator comes on when the oven heats up.
- The lamp comes on when the appliance operates.
- The symbol shows whether the knob controls the oven functions or the temperature.

1. Turn the knob for the oven functions to select an oven function.
2. Turn the knob for the temperature to select a temperature.
3. To deactivate the appliance turn the knobs for the oven functions and temperature to the off position.

5.3 Oven functions

Oven function	Application
0 Off position	The appliance is off.
 Light	To activate the lamp without a cooking function.
 True Fan Cooking	To bake on up to 3 shelf positions at the same time and to dry food. Set the temperature 20 - 40 °C lower than for Top / Bottom Heat.
 Pizza Setting	To bake food on 1 shelf position for a more intensive browning and a crispy bottom. Set the temperature 20 - 40 °C lower than for Top / Bottom Heat.
 Top / Bottom Heat	To bake and roast food on 1 shelf position.
 Bottom Heat	To bake cakes with crispy bottom and to preserve food.
 Defrost	To defrost frozen food.
 Grilling	To grill flat food and to toast bread.
 Fast Grilling	To grill flat food in large quantities and to toast bread.
 Turbo Grilling	To roast larger meat joints or poultry with bones on 1 shelf position. Also to make gratins and to brown.

5.4 Display

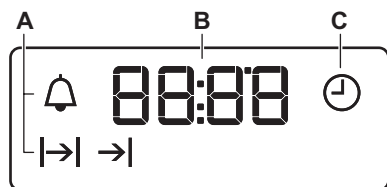





- A) Function indicators
- B) Time display
- C) Function indicator





5.5 Buttons

Button	Function	Description
—	MINUS	To set the time.
	CLOCK	To set a clock function.
+	PLUS	To set the time.



6. CLOCK FUNCTIONS



6.1 Clock functions table

Clock function	Application
 Time of day	To set, change or check the time of day.
 Minute Minder	To set countdown time. This function has no effect on the operation of the appliance.
 Duration	To set the cooking time of the oven.
 End	To set the time of day when the oven should deactivate.

 You can use the functions Duration  and End  at the same time to set the time for how long the appliance should operate and when the appliance should deactivate. This lets you activate the appliance with a delay in time. First set the Duration  and then the End .



6.2 Setting the clock functions

For Duration  and End , set an oven function and temperature of cooking. This is not necessary for the Minute Minder .



1. Press  again and again until the indicator for the necessary clock function starts to flash.
2. Press  or  to set the time for the necessary clock function.

The clock function operates. The display shows the indicator for the clock function you set.

-  For the Minute Minder function the display shows the time left.
3. When the time ends the indicator of the clock function flashes and an acoustic signal sounds. Press a button to stop the signal.
 4. Turn the knob for the oven functions and the knob for the temperature to the off position.

 With the Duration  and End  functions, the appliance deactivates automatically.

6.3 Cancelling the clock functions

1. Press the  again and again until the necessary function indicator flashes.
2. Press and hold .

The clock function goes out after some seconds.

7. USING THE ACCESSORIES



WARNING!
Refer to Safety chapters.

7.1 Inserting the accessories

Wire shelf:

Push the shelf between the guide bars of the shelf support and make sure that the feet point down.

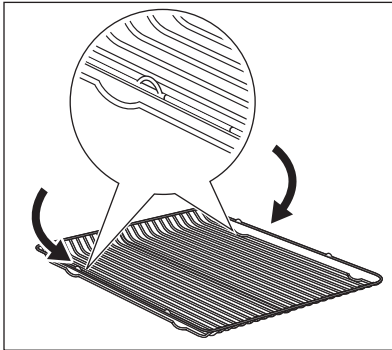

Deep pan:

Push the deep pan between the guide bars of the shelf support.

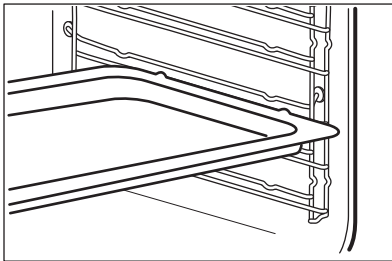

Wire shelf and the deep pan together:

Push the deep pan between the guide bars of the shelf support and the wire shelf on the guide bars above.

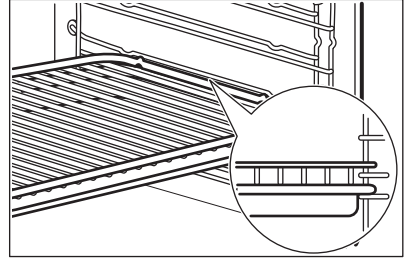

- All accessories have small indentations at the top of the right and left side to increase safety. The indentations are also anti-tip devices.
- The high rim around the shelf is a device which prevents cookware from slipping.

8. ADDITIONAL FUNCTIONS

8.1 Cooling fan

When the appliance operates, the cooling fan activates automatically to keep the surfaces of the appliance cool.

If you deactivate the appliance, the cooling fan can continue to operate until the appliance cools down.

9. HINTS AND TIPS



WARNING!

Refer to Safety chapters.



The temperature and baking times in the tables are guidelines only. They depend on the recipes and the quality and quantity of the ingredients used.

9.1 Inner side of the door

In some models, on the inner side of the door you can find:

- the numbers of the shelf positions.
- information about the oven functions, recommended shelf positions and temperatures for typical dishes.

9.2 Baking

- Your oven can bake or roast differently to the appliance you had before. Adapt your usual settings (temperature, cooking times) and

- shelf positions to the values in the tables.
- The manufacturer recommends that you use the lower temperature the first time.
- If you cannot find the settings for a special recipe, look for the one that is almost the same.
- You can extend baking times by 10 – 15 minutes if you bake cakes on more than one shelf position.
- Cakes and pastries at different heights do not always brown equally at first. If this occurs, do not change the temperature setting. The differences equalize during the baking procedure.
- With longer baking times, you can deactivate the oven approximately 10 minutes before the end of the baking time and then use the residual heat.

When you cook frozen food, the trays in the oven can twist during baking. When the trays become cold again, the distortions are gone.

9.3 Tips on baking

Baking results	Possible cause	Remedy
The bottom of the cake is not browned sufficiently.	The shelf position is incorrect.	Put the cake on a lower shelf.
The cake sinks and becomes soggy, lumpy or streaky.	The oven temperature is too high.	The next time you bake, set a slightly lower oven temperature.
The cake sinks and becomes soggy, lumpy or streaky.	The baking time is too short.	Set a longer baking time. You cannot decrease baking times by setting higher temperatures.
The cake sinks and becomes soggy, lumpy or streaky.	There is too much liquid in the mixture.	Use less liquid. Be careful with mixing times, especially if you use a mixing machine.
The cake is too dry.	The oven temperature is too low.	The next time you bake, set a higher oven temperature.
The cake is too dry.	The baking time is too long.	The next time you bake, set a shorter baking time.

Baking results	Possible cause	Remedy
The cake browns unevenly.	The oven temperature is too high and the baking time is too short.	Set a lower oven temperature and a longer baking time.
The cake browns unevenly.	The mixture is unevenly distributed.	Spread the mixture evenly on the baking tray.
The cake is not ready in the baking time given.	The oven temperature is too low.	The next time you bake, set a slightly higher oven temperature.

9.4 Baking on one level:

Baking in tins

Food	Function	Temperature (°C)	Time (min)	Shelf position
Ring cake / Brioche	True Fan Cooking	150 - 160	50 - 70	1
Madeira cake / Fruit cakes	True Fan Cooking	140 - 160	70 - 90	1
Fatless sponge cake / Fatless sponge cake	True Fan Cooking	140 - 150	35 - 50	2
Fatless sponge cake / Fatless sponge cake	Top / Bottom Heat	160	35 - 50	2
Flan base - short pastry	True Fan Cooking	170 - 180 ¹⁾	10 - 25	2
Flan base - sponge mixture	True Fan Cooking	150 - 170	20 - 25	2
Apple pie / Apple pie (2 tins Ø20 cm, diagonally off set)	True Fan Cooking	160	60 - 90	2
Apple pie / Apple pie (2 tins Ø20 cm, diagonally off set)	Top / Bottom Heat	180	70 - 90	1
Cheesecake	Top / Bottom Heat	170 - 190	60 - 90	1

¹⁾ Preheat the oven.

Cakes / pastries / breads on baking trays

Food	Function	Temperature (°C)	Time (min)	Shelf position
Plaited bread / Bread crown	Top / Bottom Heat	170 - 190	30 - 40	3
Christmas stollen	Top / Bottom Heat	160 - 180 ¹⁾	50 - 70	2
Bread (rye bread): 1. First part of baking procedure. 2. Second part of baking procedure.	Top / Bottom Heat	1. 230 ¹⁾ 2. 160 - 180	1. 20 2. 30 - 60	1
Cream puffs / Eclairs	Top / Bottom Heat	190 - 210 ¹⁾	20 - 35	3
Swiss roll	Top / Bottom Heat	180 - 200 ¹⁾	10 - 20	3
Cake with crumble topping (dry)	True Fan Cooking	150 - 160	20 - 40	3
Buttered almond cake / Sugar cakes	Top / Bottom Heat	190 - 210 ¹⁾	20 - 30	3
Fruit flans (made with yeast dough / sponge mixture) ²⁾	True Fan Cooking	150	35 - 55	3
Fruit flans (made with yeast dough / sponge mixture) ²⁾	Top / Bottom Heat	170	35 - 55	3
Fruit flans made with short pastry	True Fan Cooking	160 - 170	40 - 80	3

Food	Function	Temperature (°C)	Time (min)	Shelf position
Yeast cakes with delicate toppings (e.g. quark, cream, custard)	Top / Bottom Heat	160 - 180 ¹⁾	40 - 80	3

1) Preheat the oven.

2) Use a deep pan.

Biscuits

Food	Function	Temperature (°C)	Time (min)	Shelf position
Short pastry biscuits	True Fan Cooking	150 - 160	10 - 20	3
Short bread / Short bread / Pastry stripes	True Fan Cooking	140	20 - 35	3
Short bread / Short bread / Pastry stripes	Top / Bottom Heat	160 ¹⁾	20 - 30	3
Biscuits made with sponge mixture	True Fan Cooking	150 - 160	15 - 20	3
Pastries made with egg white / Meringues	True Fan Cooking	80 - 100	120 - 150	3
Macaroons	True Fan Cooking	100 - 120	30 - 50	3
Biscuits made with yeast dough	True Fan Cooking	150 - 160	20 - 40	3
Puff pastries	True Fan Cooking	170 - 180 ¹⁾	20 - 30	3
Rolls	True Fan Cooking	160 ¹⁾	10 - 25	3
Rolls	Top / Bottom Heat	190 - 210 ¹⁾	10 - 25	3
Small cakes / Small cakes (20 per tray)	True Fan Cooking	150 ¹⁾	20 - 35	3

Food	Function	Temperature (°C)	Time (min)	Shelf position
Small cakes / Small cakes (20 per tray)	Top / Bottom Heat	170 ¹⁾	20 - 30	3

¹⁾ Preheat the oven.

9.5 Bakes and gratins

Food	Function	Temperature (°C)	Time (min)	Shelf position
Pasta bake	Top / Bottom Heat	180 - 200	45 - 60	1
Lasagne	Top / Bottom Heat	180 - 200	25 - 40	1
Vegetables au gratin ¹⁾	Turbo Grilling	160 - 170	15 - 30	1
Baguettes topped with melted cheese	True Fan Cooking	160 - 170	15 - 30	1
Sweet bakes	Top / Bottom Heat	180 - 200	40 - 60	1
Fish bakes	Top / Bottom Heat	180 - 200	30 - 60	1
Stuffed vegetables	True Fan Cooking	160 - 170	30 - 60	1

¹⁾ Preheat the oven.

9.6 Multilevel Baking

Use the function True Fan Cooking.

Cakes / pastries / breads on baking trays

Food	Temperature (°C)	Time (min)	Shelf position	
			2 positions	3 positions
Cream puffs / Eclairs	160 - 180 ¹⁾	25 - 45	1 / 4	-
Dry streusel cake	150 - 160	30 - 45	1 / 4	-

¹⁾ Preheat the oven.

Biscuits / small cakes / small cakes / pastries / rolls

Food	Temperature (°C)	Time (min)	Shelf position	
			2 positions	3 positions
Short pastry biscuits	150 - 160	20 - 40	1 / 4	1 / 3 / 5
Short bread / Short bread / Pastry Stripes	140	25 - 45	1 / 4	1 / 3 / 5
Biscuits made with sponge mixture	160 - 170	25 - 40	1 / 4	-
Biscuits made with egg white, meringues	80 - 100	130 - 170	1 / 4	-
Macaroons	100 - 120	40 - 80	1 / 4	-
Biscuits made with yeast dough	160 - 170	30 - 60	1 / 4	-
Puff pastries	170 - 180 ¹⁾	30 - 50	1 / 4	-
Rolls	180	20 - 30	1 / 4	-
Small cakes / Small cakes (20 per tray)	150 ¹⁾	23 - 40	1 / 4	-

1) Preheat the oven.

9.7 Pizza Setting

Food	Temperature (°C)	Time (min)	Shelf position
Pizza (thin crust)	200 - 230 ¹⁾²⁾	15 - 20	2
Pizza (with a lot of topping)	180 - 200	20 - 30	2
Tarts	180 - 200	40 - 55	1
Spinach flan	160 - 180	45 - 60	1
Quiche Lorraine	170 - 190	45 - 55	1
Swiss Flan	170 - 190	45 - 55	1
Cheesecake	140 - 160	60 - 90	1
Apple cake, covered	150 - 170	50 - 60	1
Vegetable pie	160 - 180	50 - 60	1

Food	Temperature (°C)	Time (min)	Shelf position
Unleavened bread	230 - 250 ¹⁾	10 - 20	2
Puff pastry flan	160 - 180 ¹⁾	45 - 55	2
Flammekuchen (Pizza-like dish from Alsace)	230 - 250 ¹⁾	12 - 20	2
Piroggen (Russian version of calzone)	180 - 200 ¹⁾	15 - 25	2

1) Preheat the oven.

2) Use a deep pan.

9.8 Roasting

- Use heat-resistant ovenware to roast (refer to the instructions of the manufacturer).
- You can roast large roasting joints directly in the deep pan (if present) or on the wire shelf above the deep pan.
- Roast lean meats in the roasting tin with the lid. This keeps the meat more succulent.
- All types of meat that can be browned or have crackling can be roasted in the roasting tin without the lid.
- We recommend that you cook meat and fish weighing 1 kg and above in the appliance.
- To prevent the meat juices or fat from burning onto the pan, put some liquid into the deep pan.
- If necessary, turn the roast (after 1/2 - 2/3 of the cooking time).
- Baste large roasts and poultry with their juices several times during roasting. This gives better roasting results.
- You can deactivate the appliance approximately 10 minutes before the end of the roasting time, and use the residual heat.

9.9 Roasting tables

Beef

Food	Quantity	Function	Temperature (°C)	Time (min)	Shelf position
Pot roast	1 - 1.5 kg	Top / Bottom Heat	230	120 - 150	1
Roast beef or fillet: rare	per cm of thickness	Turbo Grilling	190 - 200 ¹⁾	5 - 6	1
Roast beef or fillet: medium	per cm of thickness	Turbo Grilling	180 - 190 ¹⁾	6 - 8	1
Roast beef or fillet: well done	per cm of thickness	Turbo Grilling	170 - 180 ¹⁾	8 - 10	1

1) Preheat the oven.

Pork

Food	Quantity	Function	Temperature (°C)	Time (min)	Shelf position
Shoulder / Neck / Ham joint	1 - 1.5 kg	Turbo Grilling	160 - 180	90 - 120	1
Chop / Spare rib	1 - 1.5 kg	Turbo Grilling	170 - 180	60 - 90	1
Meatloaf	750 g - 1 kg	Turbo Grilling	160 - 170	50 - 60	1
Pork knuckle (precooked)	750 g - 1 kg	Turbo Grilling	150 - 170	90 - 120	1

Veal

Food	Quantity (kg)	Function	Temperature (°C)	Time (min)	Shelf position
Roast veal	1	Turbo Grilling	160 - 180	90 - 120	1
Knuckle of veal	1.5 - 2	Turbo Grilling	160 - 180	120 - 150	1

Lamb

Food	Quantity (kg)	Function	Temperature (°C) Shelf position	Time (min)	Shelf position
Leg of lamb / Roast lamb	1 - 1.5	Turbo Grilling	150 - 170	100 - 120	1
Saddle of lamb	1 - 1.5	Turbo Grilling	160 - 180	40 - 60	1

Game

Food	Quantity	Function	Temperature (°C)	Time (min)	Shelf position
Saddle / Leg of hare	up to 1 kg	Top / Bottom Heat	230 ¹⁾	30 - 40	1
Saddle of venison	1.5 - 2 kg	Top / Bottom Heat	210 - 220	35 - 40	1
Haunch of venison	1.5 - 2 kg	Top / Bottom Heat	180 - 200	60 - 90	1

¹⁾ Preheat the oven.

Poultry

Food	Quantity	Function	Temperature (°C)	Time (min)	Shelf position
Poultry portions	200 - 250 g each	Turbo Grilling	200 - 220	30 - 50	1
Half chicken	400 - 500 g each	Turbo Grilling	190 - 210	35 - 50	1
Chicken, poulard	1 - 1.5 kg	Turbo Grilling	190 - 210	50 - 70	1
Duck	1.5 - 2 kg	Turbo Grilling	180 - 200	80 - 100	1
Goose	3.5 - 5 kg	Turbo Grilling	160 - 180	120 - 180	1
Turkey	2.5 - 3.5 kg	Turbo Grilling	160 - 180	120 - 150	1
Turkey	4 - 6 kg	Turbo Grilling	140 - 160	150 - 240	1

Fish (steamed)

Food	Quantity (kg)	Function	Temperature (°C)	Time (min)	Shelf position
Whole fish	1 - 1.5	Top / Bottom Heat	210 - 220	40 - 60	1

9.10 Grilling

- Always grill with the maximum temperature setting.
- Set the shelf into the shelf position as recommended in the grilling table.
- Always set the pan to collect the fat into the first shelf position.

- Grill only flat pieces of meat or fish.
- Always preheat the empty oven with the grill functions for 5 minutes.

**CAUTION!**

Always grill with the oven door closed.

Grilling

Food	Temperature (°C)	Time (min)		Shelf position
		1st side	2nd side	
Roast beef	210 - 230	30 - 40	30 - 40	2
Filet of beef	230	20 - 30	20 - 30	3
Back of pork	210 - 230	30 - 40	30 - 40	2
Back of veal	210 - 230	30 - 40	30 - 40	2
Back of lamb	210 - 230	25 - 35	20 - 25	3

Food	Temperature (°C)	Time (min)		Shelf position
		1st side	2nd side	
Whole Fish, 500 - 1000 g	210 - 230	15 - 30	15 - 30	3 / 4

Fast Grilling

Food	Time (min)		Shelf position
	1st side	2nd side	
Burgers / Burgers	8 - 10	6 - 8	4
Pork fillet	10 - 12	6 - 10	4
Sausages	10 - 12	6 - 8	4
Fillet / Veal steaks	7 - 10	6 - 8	4
Toast / Toast	1 - 3	1 - 3	5
Toast with topping	6 - 8	-	4

9.11 Frozen foods

Use the function True Fan Cooking.

Food	Temperature (°C)	Time (min)	Shelf position
Pizza, frozen	200 - 220	15 - 25	2
Pizza American, frozen	190 - 210	20 - 25	2
Pizza, chilled	210 - 230	13 - 25	2
Pizza Snacks, frozen	180 - 200	15 - 30	2
French Fries, thin	200 - 220	20 - 30	3
French Fries, thick	200 - 220	25 - 35	3
Wedges / Croquettes	220 - 230	20 - 35	3
Hash Browns	210 - 230	20 - 30	3
Lasagne / Cannelloni, fresh	170 - 190	35 - 45	2
Lasagne / Cannelloni, frozen	160 - 180	40 - 60	2
Oven baked cheese	170 - 190	20 - 30	3
Chicken Wings	190 - 210	20 - 30	2

Frozen ready meals

Food	Function	Temperature (°C)	Time (min)	Shelf position
Frozen pizza	Top / Bottom Heat	as per manufacturer's instructions	as per manufacturer's instructions	3
French fries ¹⁾ (300 - 600 g)	Top / Bottom Heat or Turbo Grilling	200 - 220	as per manufacturer's instructions	3
Baguettes	Top / Bottom Heat	as per manufacturer's instructions	as per manufacturer's instructions	3
Fruit flans	Top / Bottom Heat	as per manufacturer's instructions	as per manufacturer's instructions	3

1) Turn the French fries 2 or 3 times during cooking.

9.12 Defrost

- Remove the food packaging and put the food on a plate.
- Use the first shelf position from the bottom.
- Do not cover the food with a bowl or a plate, as this can extend the defrost time.

Food	Quantity	Defrosting time (min)	Further defrosting time (min)	Comments
Chicken	1 kg	100 - 140	20 - 30	Put the chicken on an upturned saucer in a big plate. Turn half-way through.
Meat	1 kg	100 - 140	20 - 30	Turn half-way through.
Meat	500 g	90 - 120	20 - 30	Turn half-way through.
Trout	150 g	25 - 35	10 - 15	-
Strawberries	300 g	30 - 40	10 - 20	-
Butter	250 g	30 - 40	10 - 15	-
Cream	2 x 200 g	80 - 100	10 - 15	Whip the cream when still slightly frozen in places.
Gateau	1.4 kg	60	60	-

9.13 Preserving - Bottom Heat

- Use only preserve jars of the same dimensions available on the market.
- Do not use jars with twist-off and bayonet type lids or metal tins.
- Use the first shelf from the bottom for this function.

- Put no more than six one-litre preserve jars on the baking tray.
- Fill the jars equally and close with a clamp.
- The jars cannot touch each other.
- Put approximately 1/2 litre of water into the baking tray to give sufficient moisture in the oven.
- When the liquid in the jars starts to simmer (after approximately 35 - 60 minutes with one-litre jars), stop the oven or decrease the temperature to 100 °C (see the table).

Soft fruit

Food	Temperature (°C)	Cooking time until simmering (min)	Continue to cook at 100 °C (min)
Strawberries / Blueberries / Raspberries / Ripe gooseberries	160 - 170	35 - 45	-

Stone fruit

Food	Temperature (°C)	Cooking time until simmering (min)	Continue to cook at 100 °C (min)
Pears / Quinces / Plums	160 - 170	35 - 45	10 - 15

Vegetables

Food	Temperature (°C)	Cooking time until simmering (min)	Continue to cook at 100 °C (min)
Carrots ¹⁾	160 - 170	50 - 60	5 - 10
Cucumbers	160 - 170	50 - 60	-
Mixed pickles	160 - 170	50 - 60	5 - 10
Kohlrabi / Peas / Asparagus	160 - 170	50 - 60	15 - 20

1) Leave standing in the oven after it is deactivated.

9.14 Drying - True Fan Cooking

- Cover trays with grease proof paper or baking parchment.
- For a better result, stop the oven halfway through the drying time, open

the door and let it cool down for one night to complete the drying.

Vegetables

Food	Temperature (°C)	Time (h)	Shelf position	
			1 position	2 positions
Beans	60 - 70	6 - 8	3	1 / 4
Peppers	60 - 70	5 - 6	3	1 / 4

Food	Temperature (°C)	Time (h)	Shelf position	
			1 position	2 positions
Vegetables for sour	60 - 70	5 - 6	3	1 / 4
Mushrooms	50 - 60	6 - 8	3	1 / 4
Herbs	40 - 50	2 - 3	3	1 / 4

Fruit

Food	Temperature (°C)	Time (h)	Shelf position	
			1 position	2 positions
Plums	60 - 70	8 - 10	3	1 / 4
Apricots	60 - 70	8 - 10	3	1 / 4
Apple slices	60 - 70	6 - 8	3	1 / 4
Pears	60 - 70	6 - 9	3	1 / 4

10. CARE AND CLEANING



WARNING!

Refer to Safety chapters.

10.1 Notes on cleaning

- Clean the front of the appliance with a soft cloth with warm water and a cleaning agent.
- To clean metal surfaces, use a usual cleaning agent.
- Clean the appliance interior after each use. Fat accumulation or other food remains may result in a fire. The risk is higher for the grill pan.
- Clean stubborn dirt with a special oven cleaner.
- Clean all accessories after each use and let them dry. Use a soft cloth with warm water and a cleaning agent.
- If you have nonstick accessories, do not clean them using aggressive agents, sharp-edged objects or a dishwasher. It can cause damage to the nonstick coating.

10.2 Removing the shelf supports

To clean the oven, remove the shelf supports.

1. Pull the front of the shelf support away from the side wall.

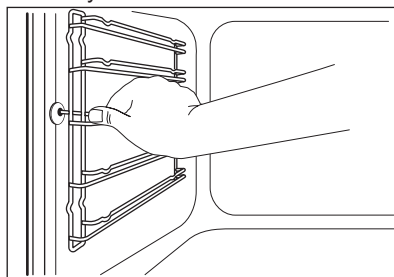

2. Pull the rear end of the shelf support away from the side wall and remove it.

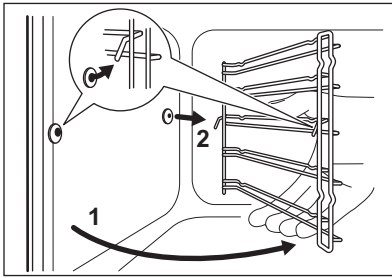

Install the shelf supports in the opposite sequence.

10.3 Oven ceiling



WARNING!

Deactivate the appliance before you remove the heating element. Make sure that the appliance is cold. There is a risk of burns.

Remove the shelf supports.

You can fold down the heating element on the oven ceiling to clean the oven ceiling easily.

1. Hold the heating element with two hands at the front.
2. Pull it forwards against the spring pressure and out along the supports on the two sides.

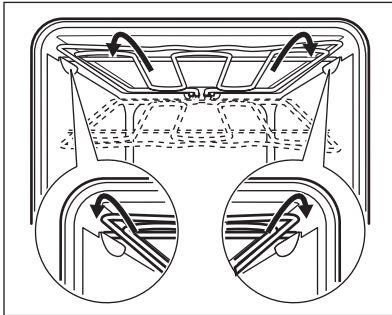

The heating element folds down.

3. Clean the oven ceiling.
4. Install the heating element in the opposite sequence.



Install the heating element correctly above the supports on the inner walls of the appliance.

5. Install the shelf supports.

10.4 Removing and installing the door

You can remove the door and the internal glass panels to clean it. The number of glass panels is different for different models.



WARNING!

Be careful when you remove the door from the appliance. The door is heavy.

1. Open the door fully.
2. Fully press the clamping levers (A) on the two door hinges.

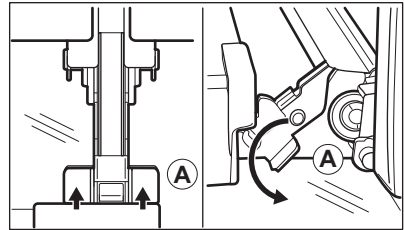

3. Close the oven door to the first opening position (approximately 70° angle).
4. Hold the door with one hand on each side and pull it away from the appliance at an upwards angle.
5. Put the door with the outer side down on a soft cloth on a stable surface. This is to prevent scratches.
6. Hold the door trim (B) on the top edge of the door at the two sides and push inwards to release the clip seal.

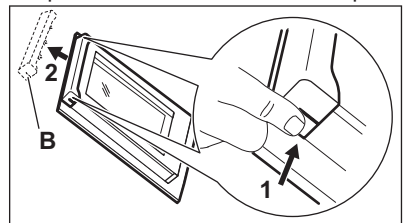

7. Pull the door trim to the front to remove it.
8. Hold the door glass panels on their top edge one by one and pull them up out of the guide.

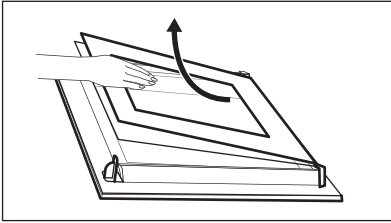

9. Clean the glass panel with water and soap. Dry the glass panel carefully. When the cleaning is completed, install the glass panels and the door. Do the above steps in the opposite sequence. Install the smaller panel first, then the larger.

10.5 Replacing the lamp

Put a cloth on the bottom of the interior of the appliance. It prevents damage to the lamp glass cover and the cavity.



WARNING!

Danger of electrocution!
Disconnect the fuse before you replace the lamp.
The lamp and the lamp glass cover can be hot.

1. Deactivate the appliance.
2. Remove the fuses from the fuse box or deactivate the circuit breaker.

The top lamp

1. Turn the lamp glass cover counterclockwise to remove it.

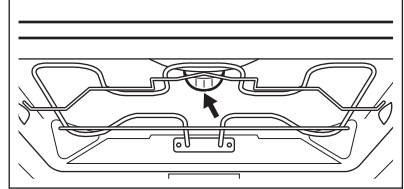

2. Clean the glass cover.
3. Replace the lamp with a suitable 300 °C heat-resistant lamp.
4. Install the glass cover.

11. TROUBLESHOOTING



WARNING!

Refer to Safety chapters.

11.1 What to do if...

Problem	Possible cause	Remedy
You cannot activate or operate the oven. The display shows "400" and an acoustic signal sounds.	The oven is incorrectly connected to an electrical supply.	Check if the oven is correctly connected to the electrical supply (refer to the connection diagram if available).
The oven does not heat up.	The oven is deactivated.	Activate the oven.
The oven does not heat up.	The clock is not set.	Set the clock.
The oven does not heat up.	The necessary settings are not set.	Make sure that the settings are correct.

Problem	Possible cause	Remedy
The oven does not heat up.	The fuse is released.	Make sure that the fuse is the cause of the malfunction. If the fuse releases again and again, contact a qualified electrician.
The lamp does not operate.	The lamp is defective.	Replace the lamp.
Steam and condensation settle on the food and in the cavity of the oven.	You left the dish in the oven for too long.	Do not leave the dishes in the oven for longer than 15 - 20 minutes after the cooking process ends.
The display shows "12.00".	There was a power cut.	Reset the clock.

11.2 Service data

If you cannot find a solution to the problem yourself, contact your dealer or an Authorised Service Centre.

The necessary data for the service centre is on the rating plate. The rating

plate is on the front frame of the appliance cavity. Do not remove the rating plate from the appliance cavity.

We recommend that you write the data here:	
Model (MOD.)
Product number (PNC)
Serial number (S.N.)

12. ENERGY EFFICIENCY

12.1 Product Fiche and information according to EU 65-66/2014

Supplier's name	Electrolux
Model identification	EOB5410BOX
Energy Efficiency Index	103.5
Energy efficiency class	A
Energy consumption with a standard load, conventional mode	0.99 kWh/cycle
Energy consumption with a standard load, fan-forced mode	0.88 kWh/cycle
Number of cavities	1
Heat source	Electricity

Volume	71 l
Type of oven	Built-In Oven
Mass	36.5 kg

EN 60350-1 - Household electric cooking appliances - Part 1: Ranges, ovens, steam ovens and grills - Methods for measuring performance.

12.2 Energy saving

The appliance contains features which help you save energy during everyday cooking.

- **General hints**

- Make sure that the oven door is closed properly when the appliance operates and keep it closed as much as possible during the cooking.
- Use metal dishes to improve the energy saving.
- When possible, put the food inside the oven without heating it up.

- When the cooking duration is longer than 30 minutes, reduce the oven temperature to minimum, 3 - 10 minutes before the end of the cooking time, depending on the duration of the cooking. The residual heat inside the oven will continue to cook.
- Use the residual heat to warm up other foods.

- **Cooking with fan** - when possible, use the cooking functions with fan to save energy.
- **Keep food warm** - if you want to use the residual heat to keep the meal warm, choose the lowest possible temperature setting.

13. ENVIRONMENT CONCERNS

Recycle the materials with the symbol . Put the packaging in applicable containers to recycle it. Help protect the environment and human health and to recycle waste of electrical and electronic appliances. Do not dispose appliances

marked with the symbol  with the household waste. Return the product to your local recycling facility or contact your municipal office.

www.electrolux.com/shop



867316730-B-202015

